

General Description

Series CH check valves provide free flow in one direction and blocked flow in the reverse direction. The check can be located in the P port or in the T port.

Features

- Cracking pressure 2.0 Bar (30 PSI).
- Sizes:
 - CH05 – NFPA D05 / NG10 / CETOP 5
 - CH5H – NFPA D05HE / NG10 / CETOP 5H
 - CH07 – NFPA D07 / NG16 / CETOP 7
 - CH08 – NFPA D08 / NG25 / CETOP 8

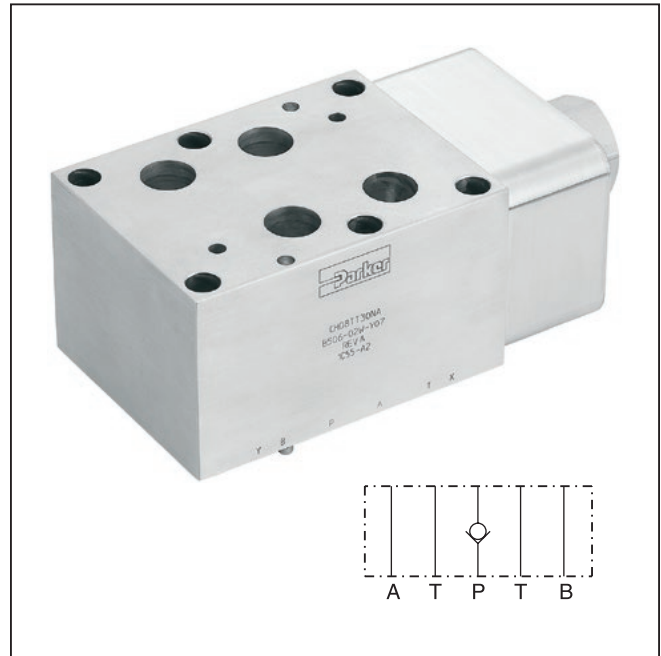

Specifications

General					
Size		D05 / NG10	D05HE / NG10	D07 / NG16	D08 / NG25
Mounting Position		Unrestricted			
Ambient Temperature Range		-20°C to +50°C (-4°F to +122°F)			
Hydraulic					
Maximum Operating Pressure		Aluminum Body – up to 207 Bar (3000 PSI); Ductile Iron Body – up to 345 Bar (5000 PSI)			
Nominal Flow		151 LPM (40 GPM)	151 LPM (40 GPM)	303 LPM (80 GPM)	606 LPM (160 GPM)
Leakage		< 1 DPM	< 1 DPM	< 1 DPM	< 1 DPM
Fluid Temperature		-20°C to +80°C (-4°F to +176°F)			
Viscosity	Permitted Recommended	10 to 650 cSt / mm ² /s (46 to 3013 SSU) 30 cSt / mm ² /s (139 SSU)			
Filtration		ISO Class 4406 (1999) 18/16/13 (acc. NAS 1638: 7)			

CH
 Direct Operated
 Check Valve

Size

Code	Description
03	See CM2
05	NFPA D05 / NG10
5H*	NFPA D05HE / NG10
07	NFPA D07 / NG16
08	NFPA D08 / NG25

* Valve comes with D05HE (ISO) pattern seal plate (990-120-012). If D05H pattern is required, order seal plate kit 990-120-009.

Style

Code	Description
PP	Blocked in P
TT	Blocked in T

30

Cracking
 Pressure

Code	Description
30	2 Bar (30 PSI)

Seal

Code	Description
N	Nitrile
V*	Fluorocarbon

* Upon request.

Body
 Material

Code	Description
A	Aluminum
D	Ductile Iron

CHPP**

blocked in P

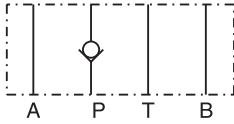

CHTT**

blocked in T

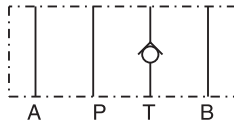

Weight:

Size	CH**PP30NA	CH**PP30ND	CH**TT30NA	CH**TT30ND
CH05, CH5H	0.8 kg (1.9 lbs.)	1.9 kg (4.2 lbs.)	0.8 kg (1.9 lbs.)	1.9 kg (4.2 lbs.)
CH07	2.2 kg (4.9 lbs.)	4.9 kg (10.9 lbs.)	2.7 kg (6.0 lbs.)	6.2 kg (13.7 lbs.)
CH08	4.7 kg (10.4 lbs.)	10.8 kg (23.8 lbs.)	5.3 kg (11.7 lbs.)	12.4 kg (27.3 lbs.)

CH05/CH5H

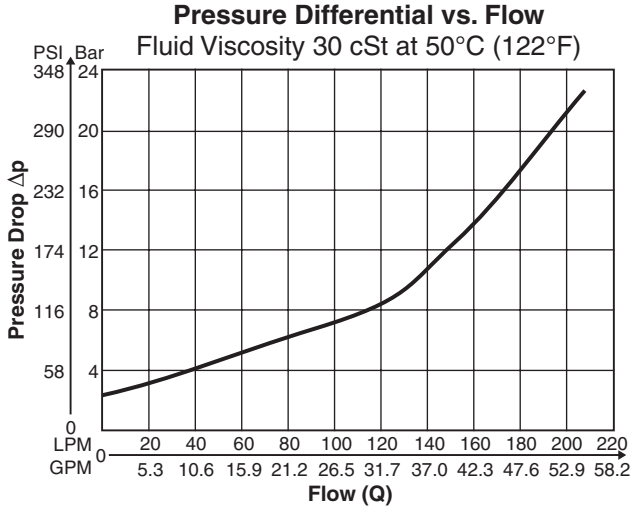

CH07

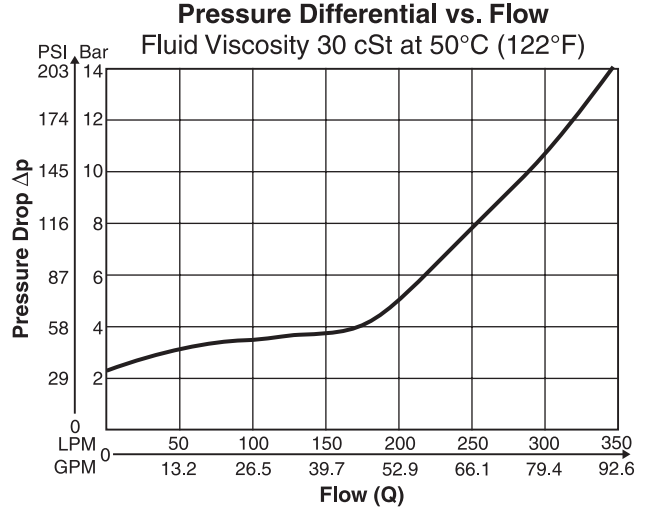

CH08

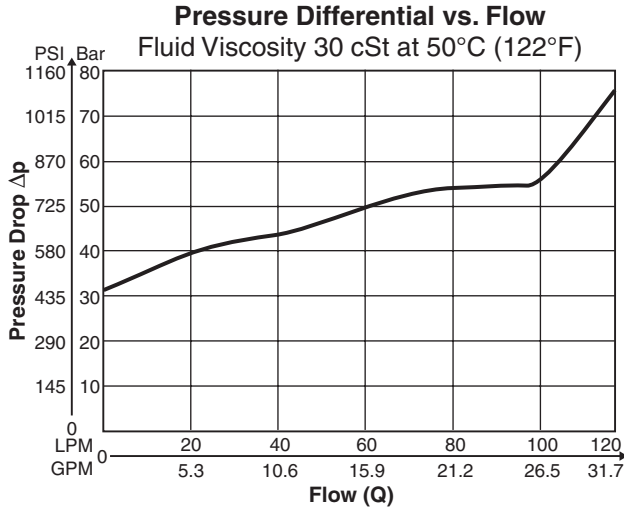

Dimensions

**Sandwich Valves
Series CH**

CH05PP

Inch equivalents for millimeter dimensions are shown in (**)

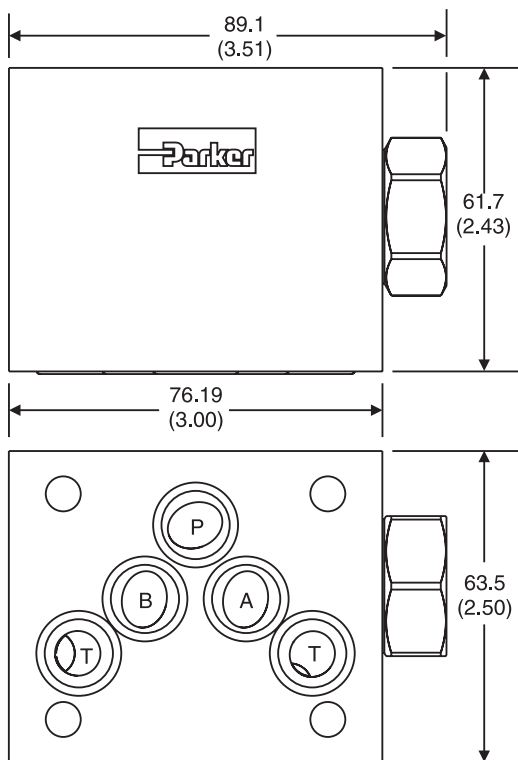

CH05TT

Inch equivalents for millimeter dimensions are shown in (**)

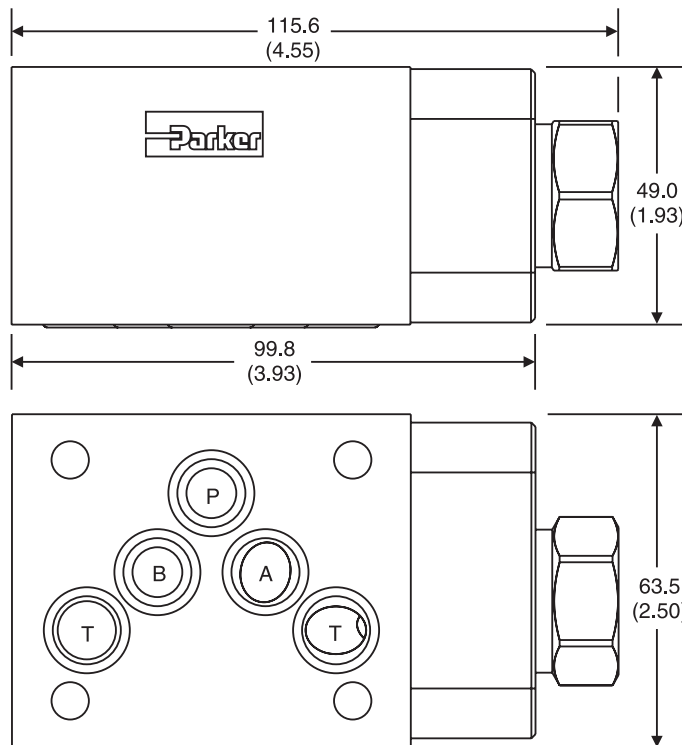

CH5HPP

Inch equivalents for millimeter dimensions are shown in (**)

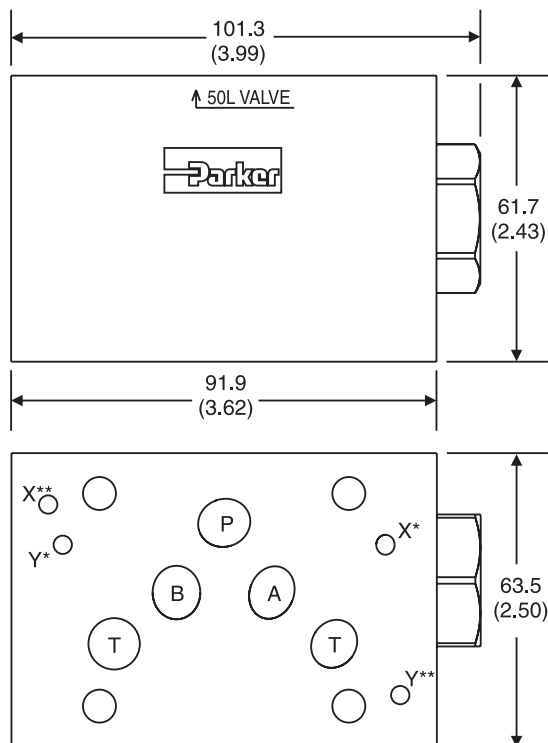

CH5HTT

Inch equivalents for millimeter dimensions are shown in (**)

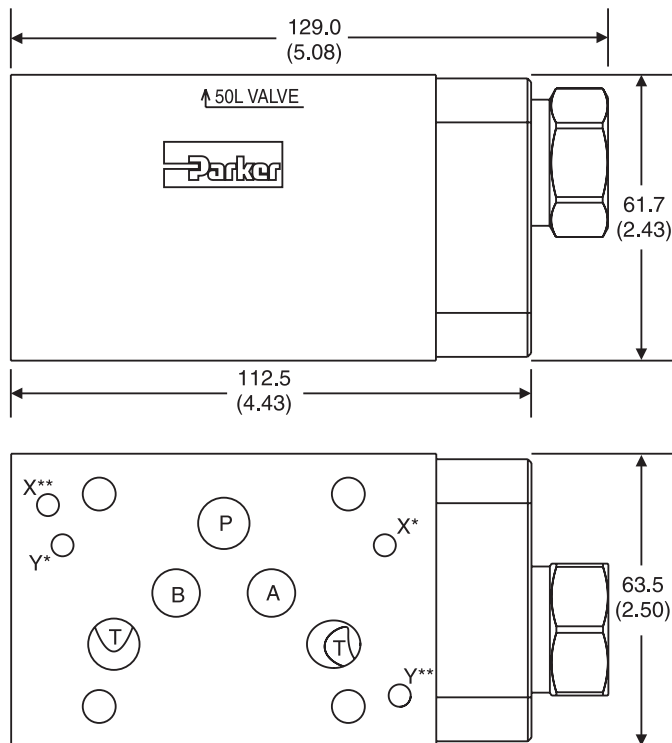

* D05HE (Standard) Valve comes with D05HE (ISO) pattern seal plate (990-120-012).
 ** D05H If D05H pattern is required, order seal plate kit 990-120-009.

* D05HE (Standard) Valve comes with D05HE (ISO) pattern seal plate (990-120-012).
 ** D05H If D05H pattern is required, order seal plate kit 990-120-009.



Dimensions

CH07PP – Inch equivalents for millimeter dimensions are shown in (**)

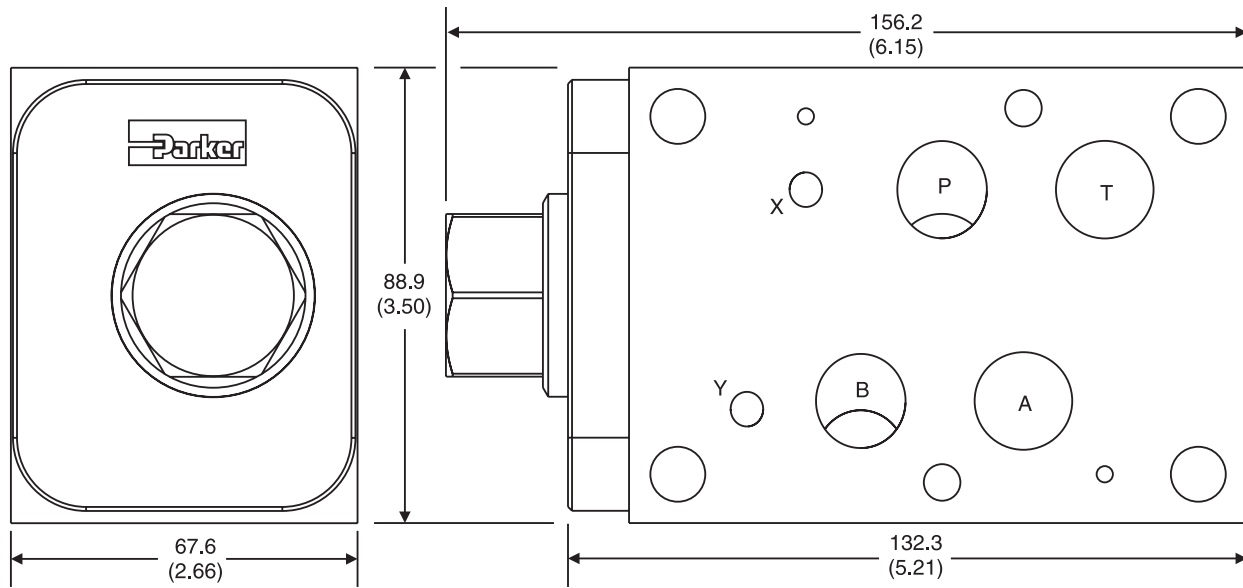

CH07TT – Inch equivalents for millimeter dimensions are shown in (**)

Note: This is a top view.

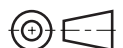
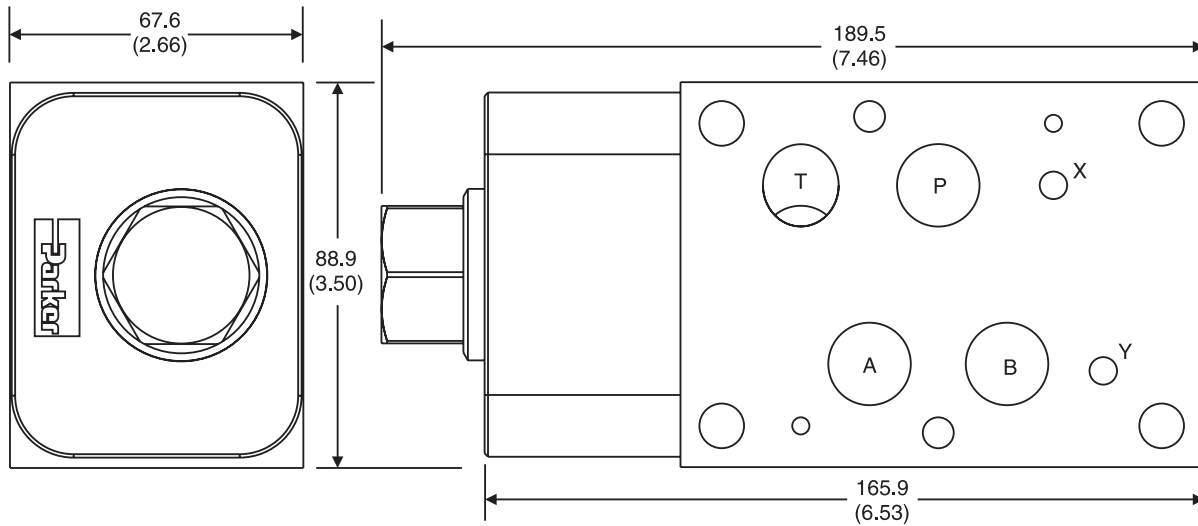

CH08PP – Inch equivalents for millimeter dimensions are shown in (**)

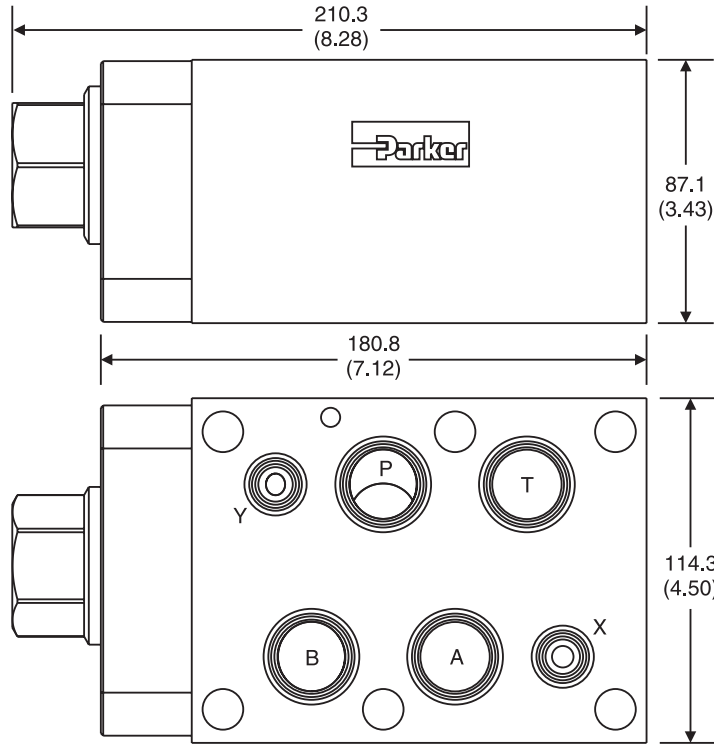

CH08TT – Inch equivalents for millimeter dimensions are shown in (**)

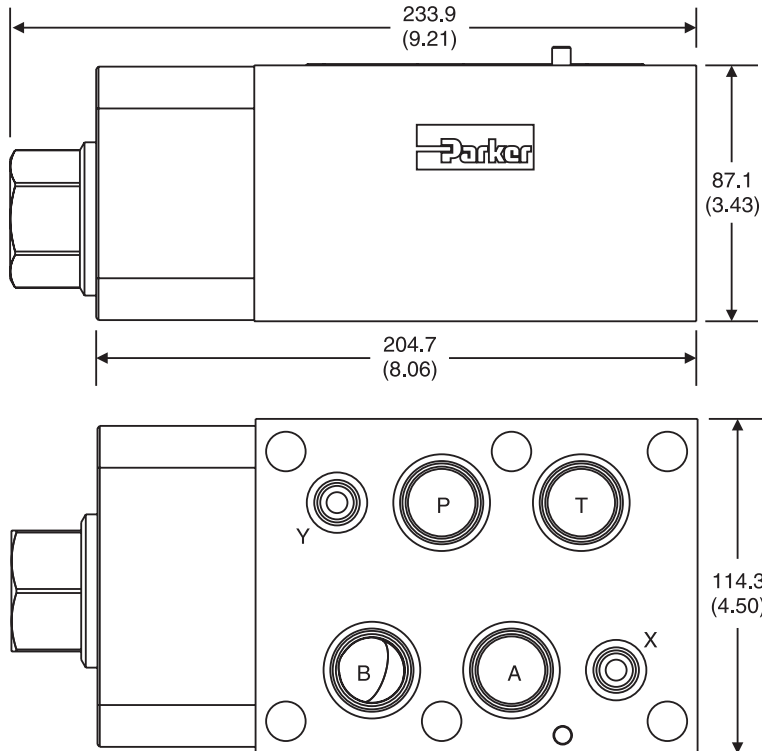



WARNING – USER RESPONSIBILITY

FAILURE OR IMPROPER SELECTION OR IMPROPER USE OF THE PRODUCTS DESCRIBED HEREIN OR RELATED ITEMS CAN CAUSE DEATH, PERSONAL INJURY AND PROPERTY DAMAGE.

- This document and other information from Parker-Hannifin Corporation, its subsidiaries and authorized distributors provide product or system options for further investigation by users having technical expertise.
- The user, through its own analysis and testing, is solely responsible for making the final selection of the system and components and assuring that all performance, endurance, maintenance, safety and warning requirements of the application are met. The user must analyze all aspects of the application, follow applicable industry standards, and follow the information concerning the product in the current product catalog and in any other materials provided from Parker or its subsidiaries or authorized distributors.
- To the extent that Parker or its subsidiaries or authorized distributors provide component or system options based upon data or specifications provided by the user, the user is responsible for determining that such data and specifications are suitable and sufficient for all applications and reasonably foreseeable uses of the components or systems.

OFFER OF SALE

The items described in this document are hereby offered for sale by Parker-Hannifin Corporation, its subsidiaries or its authorized distributors. This offer and its acceptance are governed by the provisions stated in the detailed "Offer of Sale" elsewhere in this document or available at www.parker.com/hydraulicvalve.

SAFETY GUIDE

For safety information, see Safety Guide SG HY14-1000 at www.parker.com/safety or call 1-800-CParker.



Parker Hannifin Corporation
Hydraulic Valve Division
520 Ternes Avenue
Elyria, Ohio 44035 USA
Tel: 440 366 5100
Fax: 440 366 5253
www.parker.com/hydraulicvalve

